







# Table of Contents



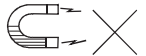

- 1. Precautions. . . . . 1
- 2. Packing List. . . . . 2
- 3. Overview . . . . . 3
- 4. Indoor Unit. . . . . 3/4
- 5. Outdoor Unit. . . . . 4
- 6. Installation Instructions. . . . . 5/6/7/8
- 7. Specifications. . . . . 9
- 8. Outdoor Unit . . . . . 9

## 1. Precautions



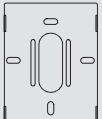

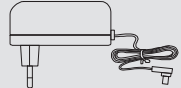
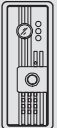
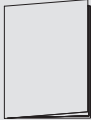

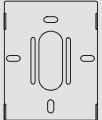

 Do not spill any other liquid on it	 Do not expose to direct sunlight
 Keep away from magnetic fields	 Avoid heavy shock or vibration
 Clean with soft, dry cloth	 Unplug the power when it is left unused for long period of time

## 2. Packing List

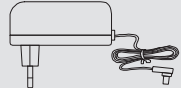
Outdoor Unit 1

 Monitor Sation X 1	 Mount Bracket X 1	 (Selection) 6Pin Cable 10m(30ft) X 1
 Power Adapter X 1	 Outdoor Unit X 1	 User's Manual X 1
 Nail glue X 6	 Screw X 6	

Outdoor Unit 2

 Monitor Sation X 1	 Mount Bracket X 1	 (Selection) 6Pin Cable 10m(30ft) X 1
 Power Adapter X 1	 Outdoor Unit X 1	 User's Manual X 1
 Nail glue X 8	 Screw X 9	 Brackets X 1

### 3. Overview

#### □ Monitor Station

1. Easy 4-wire installation between door camera and monitor.
2. Clear and bright 7" TFT LCD with LED backlight, no radio, low power consumption.
3. Monitor auto-off keeps low stand-by power.
4. Optional selective electronic door strike release.
5. Call and intercom between monitors.
6. Volume, brightness, color adjustable.
7. Power supply and 10m(30ft) wire included.
8. Expandable up to 4 monitors.

- ① ~~Monitor~~ Monitor the entrance by door camera
- ② Intercom Indicator--When the two sides intercom
- ③ Power Indicator--LED on when power is supplied
- ④ Speaker--Ding Dong and intercom speaker
- ⑤ Intercom --Intercom between each other
- ⑥ Unlock--Unlock the door if door strike applied
- ⑦ Call--Call the monitor(s) connected
- ⑧ Monitoring Button--Pick up the video from camera
- ⑨ Mic--Pick up sound for intercom
- ⑩ Brightness--Adjust the LCD screen brightness
- ⑪ Color--Adjust the LCD screen brightness
- ⑫ Volume--Adjust the voice up or down to make it clear
- ⑬ Extension button--Extended for other purposes
- ⑭ Slave Socket--Connect the expanded monitors
- ⑮ Slave Socket--Connect the expanded monitors
- ⑯ DC Input--Original DC adapter recommended only
- ⑰ Video Output--Video output to monitor

### 4. Indoor Unit

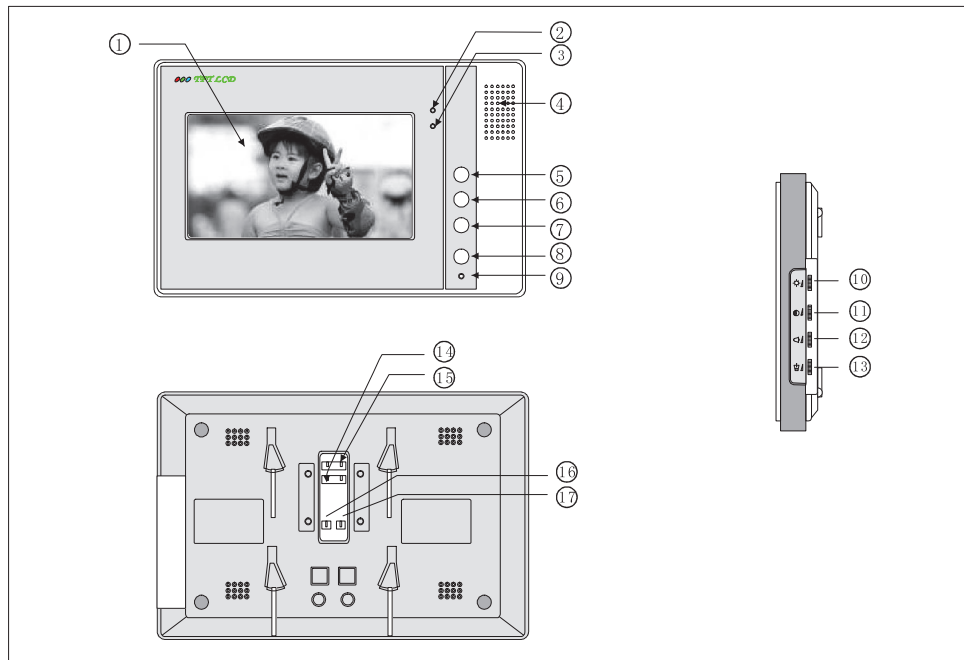

### 5. Outdoor Unit

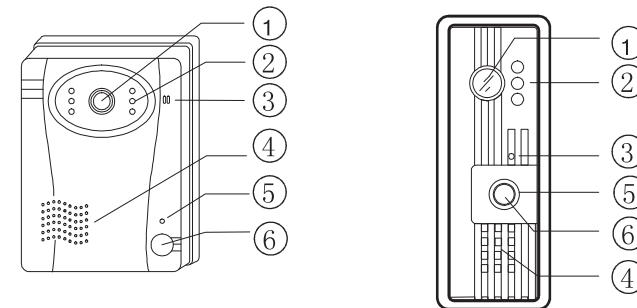

1. Camera—Pick up video.
2. Infrared light—For night vision
3. Microphone—Pick up voice of visitor.
4. Speaker— For intercom voice.
5. Indicator—LED is on when power is supplied.
6. Key—Call button.

## 6. Installation Instructions

### Monitor Station

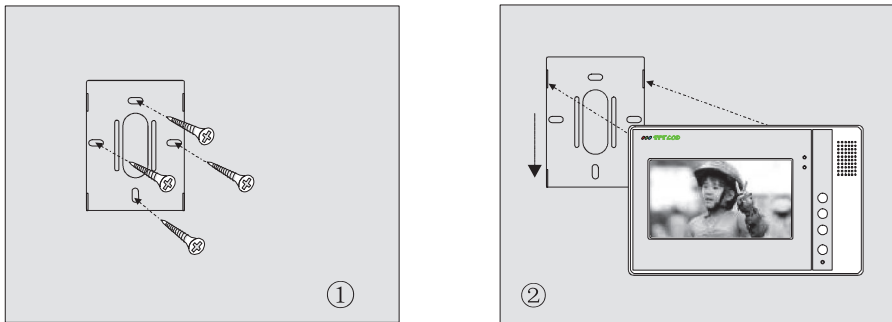

1. Install the mount bracket in proper wall place (keep the right side up).
2. Connect the wires follow the wire instructions.
3. Hang the monitor on the mount bracket and push to position.
4. Plug the DC output into monitor and plug the power adapter into wall outlet.

### Door Camera

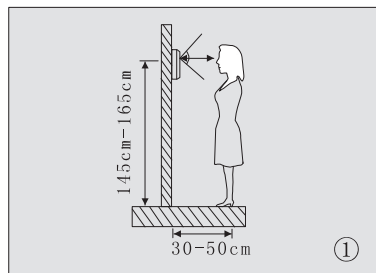

1. Pick up a proper place for door camera (figure 1)
2. The distance for the best intercom is 30 - 50 cm.

### Door Camera 1

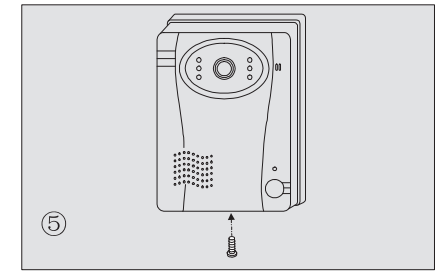
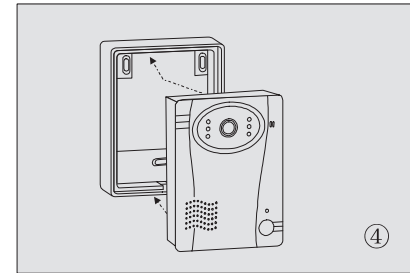
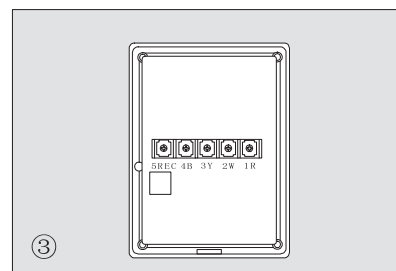
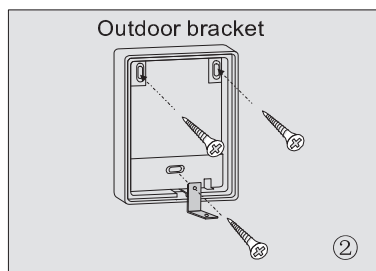

### Door Camera 2

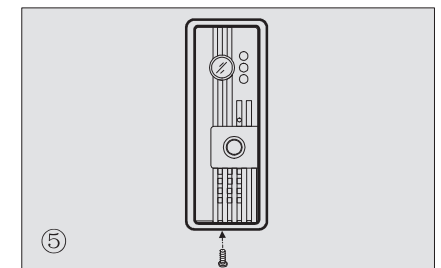
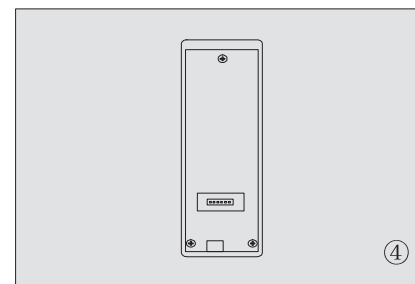
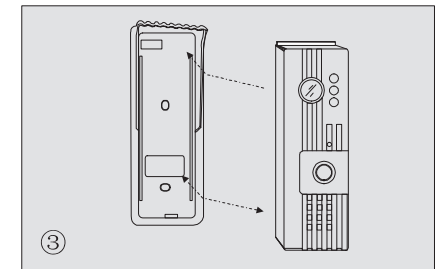
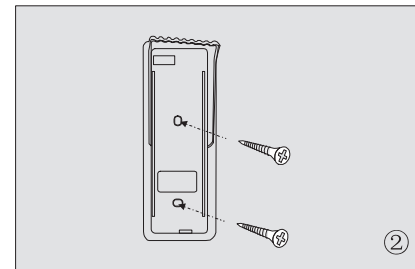

3. Mount the outdoor bracket on the wall (figure 2).
4. Connect the wires follow the wire instructions (figure 3).
5. Put the camera top into the bracket and then other part (figure 4).
6. Use screwdriver to put screw from the bottom of the camera.

## Wiring diagram

Door Camera 1

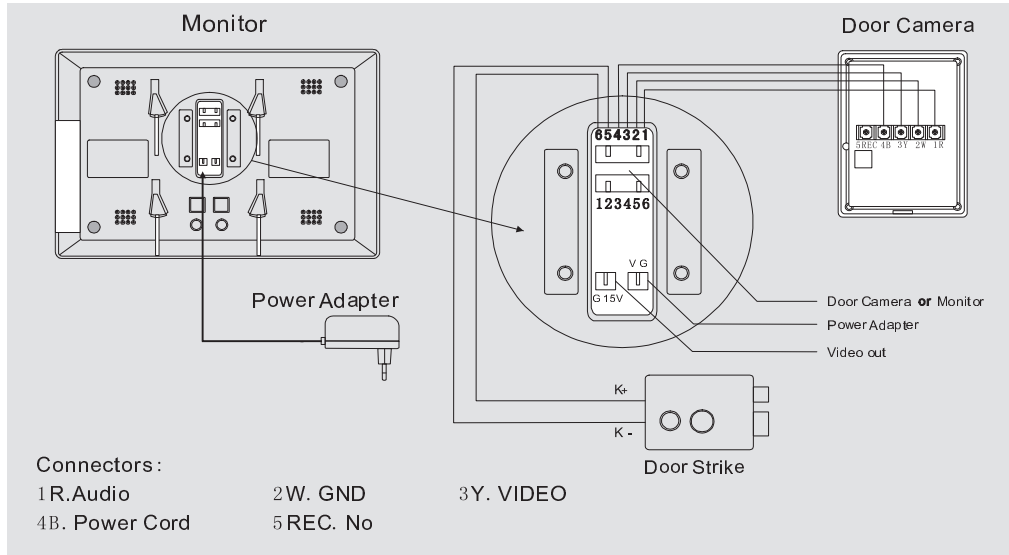

Door Camera 2

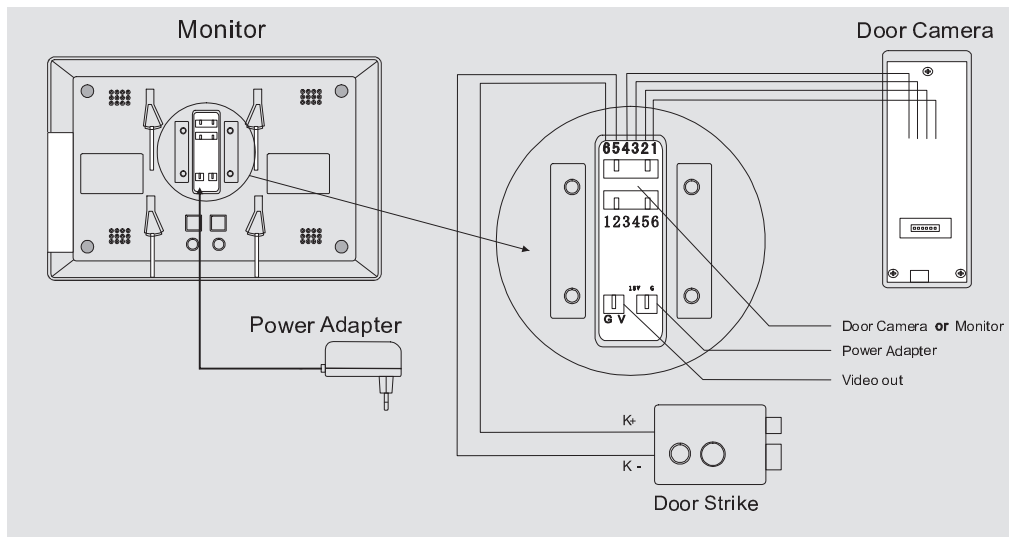

## Multi unit wiring diagram

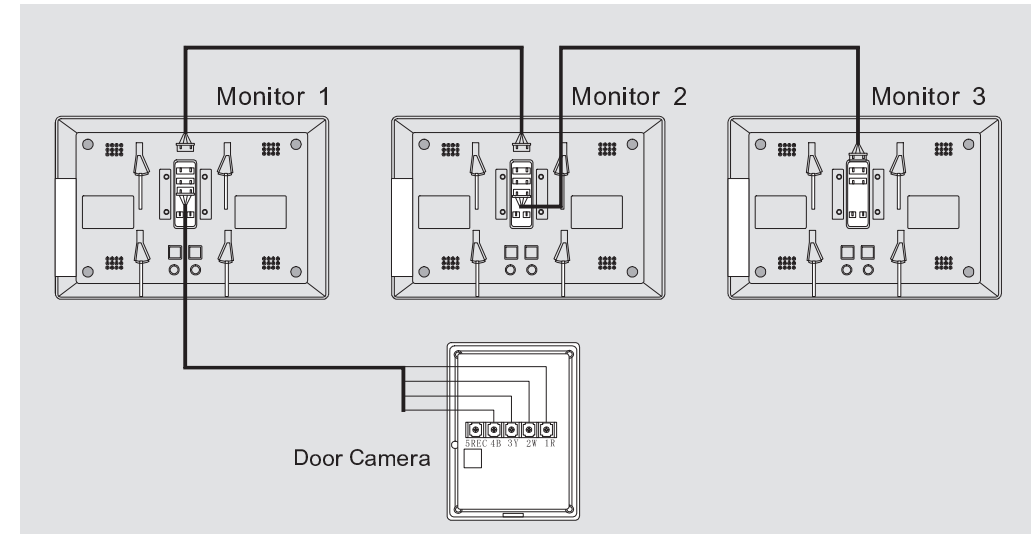

### Note:

1. Cable in package is 10m(30ft) long, 4-p AWG24 cable can be use when this cable is not long enough and the distance is within 50m. Rg59 cable recommended for video signal if the distance is more than 50m. The maximum distance is 100m between camera and monitors. 1R、2W、3Y、4B”。
2. AWG18 2-wire cable recommended for connection between monitor and door strike.